

E2617 & E2609 — BUNDLED PRICING

E2617 — Custom fabricated wheelchair back cushion
E2609 — Custom fabricated wheelchair seat cushion

Provider Information *REQUIRED

Company Name: _____

Account Number: _____

Contact Name: _____

Phone Number: _____ Email: _____

Billing Address: _____

City, State: _____ Zip Code: _____

Shipping Address: _____

City, State: _____ Zip Code: _____

Please select this box if you would like to receive digital renderings of the product prior to production.
Our seating products must be installed by Matrix Certified Providers and will not be drop shipped to end users.

Client Information *REQUIRED

First & Last Name: _____

Client Height (in.): _____" Client Weight (lbs.): _____

Special Considerations: Spasticity High Tone

Other: _____

History of Tissue Injury, Location: _____

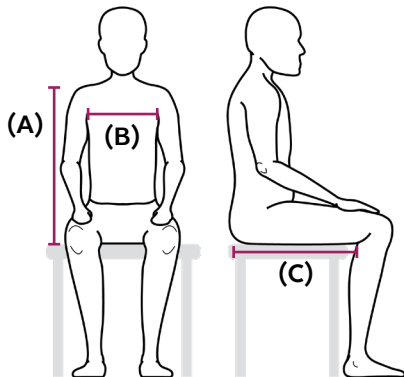

Measurements: (inches)

(A) Top of Shoulder: LEFT _____" RIGHT _____"

(B) Axillia/Internal Shoulder Width: _____"

(C) Upper Leg Lengths: LEFT _____" RIGHT _____"

Wheelchair Information *REQUIRED

Wheelchair Make: _____ Wheelchair Model: _____

Frame Width (in.): _____ Frame Depth (in.): _____

Seat Base Type: Solid Seat Sling Seat

Questions? Call 800.986.9319 or email at info@matrixseatingusa.com
Order form submission instructions can be found on the last page.

APR. 1, 2026



SELECT METHOD OF SUBMISSION — **SHAPE CAPTURE** or **TAILORED-BY-NUMBER**



Shape Capture via Scan App (Optical scan producing .OBJ file like Matrix Keen 3D, Scaniverse, etc)

For successful submission, please note the following:

ORDER FORM:

- Page 1 of the order form must be completely filled out
- Select the style of back support and/or cushion to be made along with appropriate options and modifications
- Any additional modifications needed must be detailed in the NOTES/SPECIAL INSTRUCTIONS sections

SCAN:

- Digital .OBJ file scan of mold must be provided** to info@matrixseatingusa.com
no order can be processed without scans received
- Include any reference photos and ensure trim lines and other modification markups are visible

Proceed to PRODUCT SELECTIONS on Page 3 (Page 7 if ordering cushion only)

Tailored-By-Numbers

Proceed to PRODUCT MEASUREMENTS below

Product Measurements (inches)

*A-E values needed for ordering a back support.
F-K values needed for ordering a cushion.*

BACK SUPPORT

(A) Back Height _____ ” (PRB-HT)

Overall height of the back.

(B) Inside Lateral Width _____ ” (PRB-ILW)

Internal distance between laterals.

(C) Top of Lateral to Bottom of Back (PRB-LO)

From axilla to bottom of the back (top of the seat).

Patient LEFT _____ ” (PRB-LO-L)

Patient RIGHT _____ ” (PRB-LO-R)

(D) Lateral Start Height (PRB-LSH)

Distance from the bottom of the back (top of cushion) to the bottom edge of the lateral.

Patient LEFT _____ ” (PRB-LSH-L)

Patient RIGHT _____ ” (PRB-LSH-R)

(E) Depth of Laterals (PRB-LD)

Distance from the bottom of the back (top of cushion) to the bottom edge of the lateral.

Patient LEFT _____ ” (PRB-LD-L)

Patient RIGHT _____ ” (PRB-LD-R)

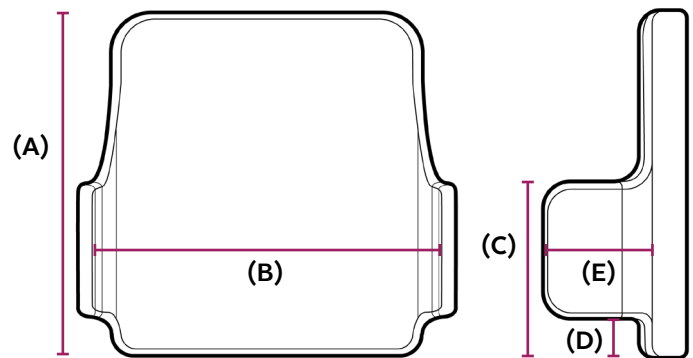

CUSHION

(F) Seat Width _____ ” (PRC-WD)

Distance from outside of lateral wall to outside of lateral wall.

(G) Seat Depth _____ ” (PRC-DP)

Overall distance from the front of the cushion, to the back edge.

(H) Leg Lengths (PRC-LA)

Only required if legs lengths are asymmetrical.

Patient LEFT _____ ” (PRC-LA-L)

Patient RIGHT _____ ” (PRC-LA-R)

(J) Abductor/Pommel Height (if any) _____ ” (PRC-ABD)

Abductor support, the standard cushion has a 1” pommel.

(K) Adductor Support (PRC-ADD)

The lateral walls of the cushion.

Patient LEFT _____ ” (PRC-ADD-L)

Patient RIGHT _____ ” (PRC-ADD-R)

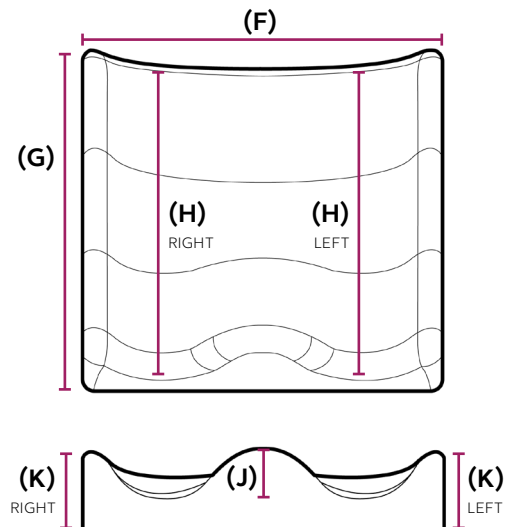

APR. 1, 2026

PRODUCT SELECTIONS

E2617 Back Support Selection

If ordering a cushion only, skip to page 7.

AIREZ Back Support (MACB-B)

\$4,198

3D printed from a proprietary high-strength nylon, providing exceptional durability, flexibility, and precision.

BACK WIDTH PRICING

<20" – Standard Trochanter Width (MACB-TSW-B)

21"– 24" – XL Trochanter Width (MACB-TXLW)

+\$355

>24" – Specialty Size (MACB-TSPW)

+\$710

Shell Style

AIREZ Standard Shell (MACB-B)

Maximizes airflow for the coolest, driest sitting experience. This design provides exceptional strength and stability; strong enough to withstand tremors, tone, and spasms.

Included

Smooth Shell (MACB-S)

Features a refined, smooth printed outer layer for a more traditional look and easier cleaning, though airflow is significantly reduced.

No Charge

ABS-X Outer Shell (MACB-ABS)

Addition of this rigid outer layer allows for simple attachment of positioning accessories. Note: Areas covered by the ABS-X shell lose airflow.

+\$485



Back Mold Modifications

Digital Relief (MACB-DR-B)

A Digital Relief is a precisely modeled off-loading zone built into a custom back support to accommodate bony prominences such as a gibbus deformity or rib hump.

**Must notate location and shape on the shape capture bag or in NOTES/SPECIAL INSTRUCTIONS if submitting via Tailored-By-Number.

Extend Patient LEFT Lateral Support _____" FORWARD of the line (MACB-EDL-L-B)

Extend Patient RIGHT Lateral Support _____" FORWARD of the line (MACB-EDL-R-B)

Increase Patient LEFT Lateral Support _____" ABOVE of the line (MACB-IHL-L-B)

Increase Patient RIGHT Lateral Support _____" ABOVE of the line (MACB-IHL-R-B)

Extend Back Height _____" ABOVE of the line (MACB-EBH-B)

APR. 1, 2026

Back Liner Options

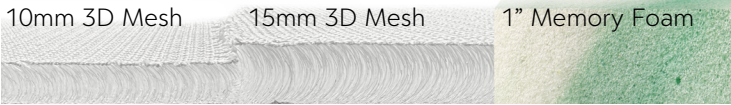

- Standard 3D Mesh Liner (10mm)** (AFBS-B)
Lightweight, soft, and highly breathable, promotes continuous airflow to reduce heat and moisture. (0.39")
- Therapeutic Premium 3D Mesh Liner (15mm)** (AFBU-B)
Adds extra shock absorption and pressure relief while maintaining airflow and softness. (0.59")
- Additional 3D Mesh Liner (10mm or 15mm)** **10mm** (AFBS-EX) **15mm** (AFBU-EX) **+\$177**
Added to the previously selected 3D Mesh Liner. Note: Additional liner will add to overall back thickness. 10mm is default if a thickness is not also selected above.
- Add Memory Foam Liner (25.4mm)** (MFBU-B)
1" foam liner added between the shell and Standard 3D Mesh Liner to make total thickness 35.4 mm (1.39").
Note: The memory foam liner does reduce airflow through the back.

Back Cover Options



- AirMesh Spacer Fabric** (CVRB-SF-B)
Open mesh material for maximum airflow.
- Additional AirMesh Spacer Fabric Cover** (CVRB-SF-EX) **+\$345**
- Dartex-Style Cover** (CVRB-DAR-B)
Smooth, anti-microbial, silver-infused fabric. Note: Dartex fabric will reduce airflow from standard AirMesh.
- Additional Dartex-Style Cover** (CVRB-DAR-EX) **+\$550**
- Additional Reverse Dartex Exterior Cover** (CVRB-IP) **+\$550**
Note: This cover will reduce airflow from standard AirMesh.
- Privacy Flap** (PF) **+\$150**

Back Hardware Options

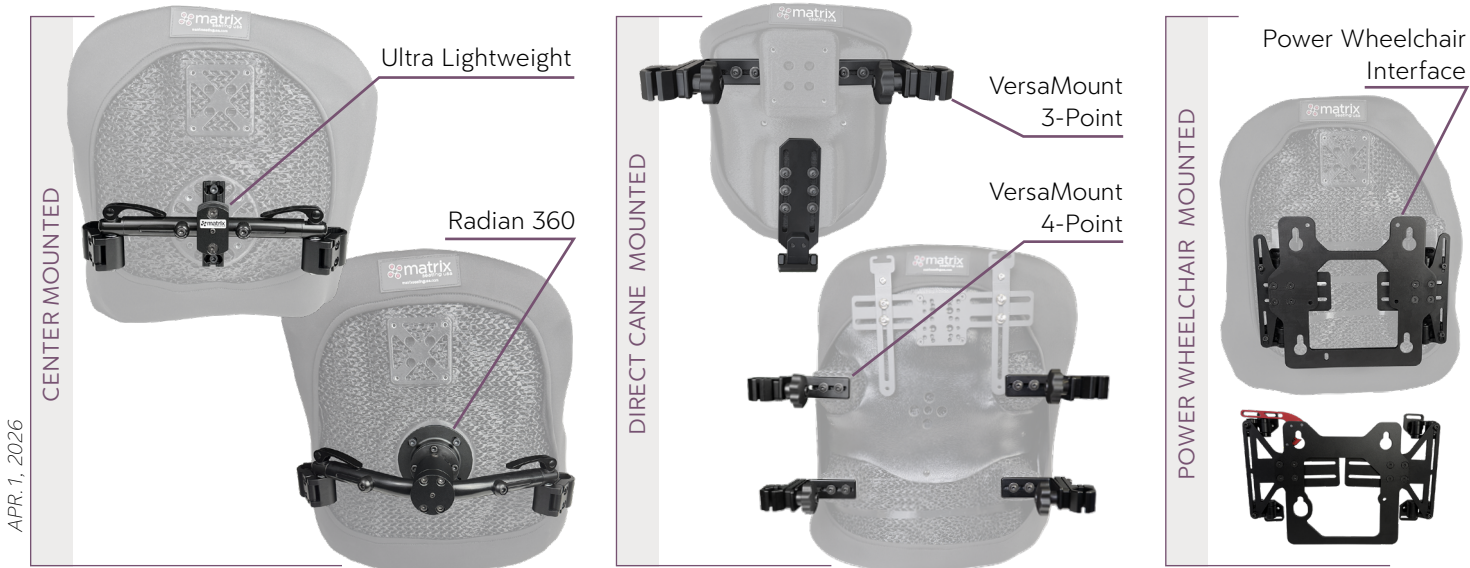

APR. 1, 2026

CENTER MOUNTED

Ultra Lightweight (VTMH-B)

Our lightest, low-profile hardware with ample adjustability for most users, ideal for self-propelling manual wheelchairs. Adjustability: Radial Rotation, Angle/Tilt, Offset Left/Right, Width.

Radian 360 (RAD-B)

A ball-and-socket design offering complete positioning flexibility. Perfect for users requiring maximum adjustability, tilt-in-space setups, or power wheelchairs with canes.

Adjustability: Radial Rotation, Horizontal Rotation, Angle, Depth, Width, Offset.

Add Additional Radian 360 (RAD-EX)

+\$595

Required for backs height 29" or more, clients over 250lbs, or for those with severe spasticity or extensor tone.

HARDWARE ATTACHMENT OPTIONS:

Fixed Hardware (FX-B)

Quick Release Hardware Upgrade (QR-B)

Cane Claw Clamps (CC-B)

NOTE: If nothing is selected, Center Mount hardware options come standard with Cane Claw Clamps.

Alternative: Flat Surface Mount (instead of Cane Claw Clamps) (SM-B)

DIRECT CANE MOUNTED

VersaMount 3-Point Hardware with Seat-to-Back Integration (VRMH-3)

3-Point Hardware is designed to unify the seat and back into one stable system, ideal for users who need strength over flexibility. NOTE: A Seat Positioning Tray with T-Nut Upgrade is also needed unless there are other means of mounting the seat bracket to the seat surface.

Include Seat Positioning Tray With T-Nut Upgrade (SC-SPT-TNU)

+\$450

VersaMount 4-Point Hardware (VRMH-4-B)

Designed for users with complex asymmetries or high-tone, high-movement presentations.

Its four anchor points provide exceptional rigidity while supporting fine-tuned alignment. This system requires more cane real estate compared to other Matrix hardware options.

POWER WHEELCHAIR MOUNTED

Power Wheelchair Interface (PWCI)

Power Wheelchair Make: _____ **Model:** _____

It is important to note the correct power wheelchair make and model for the correct bracket to be shipped. The bracket securely mounts Matrix back supports to a wide range of power wheelchair bases, maintaining its lightweight, breathable design.

Omit Hardware Options

Omit Hardware (RAD-O)

Include Hardware Installation Interface Only

The following options do not include hardware, just interfaces and pre-installed T-nuts for aftermarket hardware installation.

Center Mount Hardware Interface (CMI-B)

VersaMount 3-Point Hardware Interface (VRMH-O3-B)

VersaMount 4-Point Hardware Interface (VRMH-O4-B)

Back Support Accessories

Universal Headrest Mount (CFI-HR-B)

Universal Headrest Mount provides a stable, standardized interface for attaching most industry headrest systems. Mounting T-nuts will be added to the back support.



Omit Installation (CFI-O)

Accessory Mounting Rails on Headrest Mount (MACB-IM-B)

Accessory Mounting Rails offer a clean, integrated solution for attaching secondary supports and equipment to the back support. Mounting T-nuts will be added to the back support.

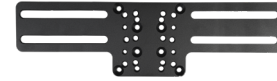

Omit Installation (MACB-O)

Shoulder Harness Guides (MACB-SHG-B)

Additional guides that attach to the Accessory Mounting Rails on Headrest Mount.

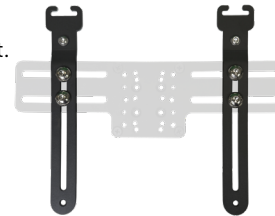

Omit Installation (MACB-SHG-O)

Shoulder Harness T-Nut Pattern Upgrade (CFI-STP)

Standard pattern of pre-installed T-nuts for easy shoulder harness installation.

+\$350

Custom T-Nut Pattern Upgrade (CFI-CTP)

The Custom T-Nut Pattern option allows clinicians to specify unique T-nut locations* on the back support to accommodate specialized harness setups, adaptive accessories, or non-traditional mounting positions.

**Must notate location and shape on the shape capture bag or in NOTES/SPECIAL INSTRUCTIONS if submitting via Tailored-By-Number.

+\$350

Growth Option

Growth Kit (MACB-GK)

The AIREZ back growth kit allows for one growth adjustment, during a 24-month coverage period. The growth adjustment only covers back height or back width. Changes in body shape or postural alignment cannot be accommodated through the growth kit.

+\$486

NOTES/SPECIAL INSTRUCTIONS

Blank lined area for notes and special instructions.

Cushion selection and options are on next pages.

APR. 1, 2026

PRODUCT SELECTIONS

E2609 Cushion Selection

AIREZ CUSHION

AIREZ 2.0 Cushion (MACSC-B)

Custom 3D printed cushion using the Golden Ratio, a proprietary blend of soft, medium, and firm elastomer fibers in a single multi-density lattice. Open lattice design provides 360° airflow that flushes heat and moisture for cooler, drier sitting. The hydrophobic material allows fluids to pass through rather than absorb, with a built-in collection tray that prevents leaks, even when tilted or reclined, and cleans easily.



\$3,219

POSTURE-FIT FOAM CUSHION

Posture+ Foam Cushion (MCSC-PP-B)

A higher-density foam, engineered to provide both exceptional support and comfort for patients requiring precise positioning.

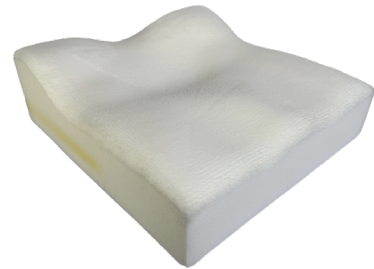

\$3,219

Relief+ Foam Cushion (MCSC-RP-B)

A softer and more versatile foam option, crafted to provide gentle, pressure-relieving support.

\$3,219

CUSHION WIDTH PRICING

10"- 20" — Standard Width (SS-W-B)

21"- 24" — XL Width (SS-XL-W)

+\$155

>24" — Specialty Width (SS-SP-W)

+\$495

Cushion Cover Options



AirMesh Spacer Fabric (CVRS-SF-B)

Open mesh material for maximum airflow.

Additional AirMesh Spacer Fabric Cover (CVRS-SF-EX)

+\$200

Dartex-Style Cover (CVRS-DAR-B)

Smooth, anti-microbial, silver-infused fabric. Note: Dartex fabric will reduce airflow from standard AirMesh.

Additional Dartex-Style Cover (CVRS-DAR-EX)

+\$295

Reverse Dartex Cover: Incontinence-Proof Interior Cover (CVRSI-IP)

+\$295

***Only recommended for patients with chronic incontinence, not recommended with AIREZ cushion.
Note: This cover will reduce airflow from standard AirMesh.

Additional Reverse Dartex Exterior Cover (CVRSE-IP)

+\$295

APR. 1, 2026

Cushion Modification Options

Undercutting (Front Undercut) (SC-UCT-B)

Undercutting removes material from the front underside of the cushion to create space beneath the distal thighs. The undercut will be 1" unless otherwise specified below.

Undercut the front of the cushion by _____”

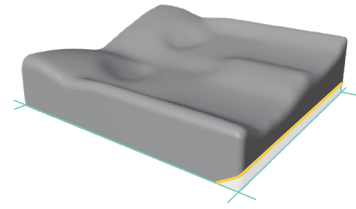

Pressure Relief Zone (AKA Soft Spot) (SC-PRZ-B)

*Only available for AIREZ or Posture+ foam cushions.

A pressure relief zone is a strategically targeted area within a seating system that provides increased immersion, softer support, or reduced loading to protect vulnerable regions.

**Must notate location and shape on the shape capture bag or in NOTES/SPECIAL INSTRUCTIONS if submitting via Tailored-By-Number.

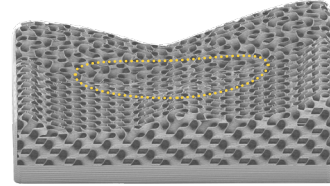

Pelvic Obliquity Build Up (Correct or Accommodate) (SC-PO-B)

A pelvic obliquity build-up is a customized adjustment added to one side of a cushion to correct or accommodate uneven pelvic height.

Patient LEFT - Increase height by _____”

Patient RIGHT - Increase height by _____”

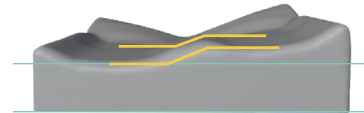

Digital Relief (SC-SS-DR-B)

A digital relief is a precisely designed area of off-loading created within a 3D printed or digitally modeled cushion to reduce pressure over sensitive or high-risk anatomical regions.

**Must notate location and shape on the shape capture bag or in NOTES/SPECIAL INSTRUCTIONS if submitting via Tailored-By-Number.

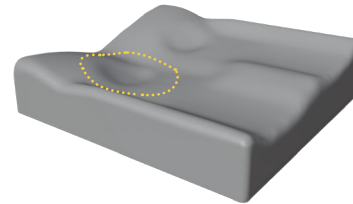

Tapered Cushion (SC-TAP-B)

A tapered cushion is designed so the front or rear of the cushion narrows to better fit the wheelchair frame and match the client's individual body dimensions.

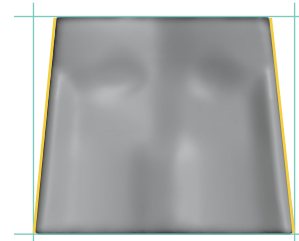

Notched Cushion (SC-NOT-B)

Cutouts/recessed areas to accommodate back canes, seat belts, or other wheelchair components.

Back Canes (SC-NOT-BC-B)

Seat Belt (SC-NOT-SB-B)

Front Notches (SC-NOT-F-B)

Rail Cutouts (SC-NOT-RC-B)

**Must notate shape and location on the shape capture bag or in NOTES/SPECIAL INSTRUCTIONS if submitting via Tailored-By-Number.

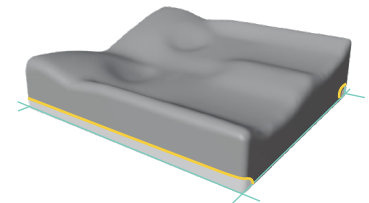

Growth Option

Eliminate Back of Cushion (SC-EBC)

A backless cushion that allows for seat depth adjustment as the patient grows.

+\$140

Growth Kit (SC-GK)

The AIREZ back growth kit allows for one growth adjustment, during a 24-month coverage period. The growth adjustment only covers back height or back width. Changes in body shape or postural alignment cannot be accommodated through the growth kit.

+\$498

APR. 1, 2026

Cushion Contour Modifications

- Seat Height (Cushion Thickness)**
 - Increase overall height by _____” (SC-THI-B)
 - As low as possible (SC-THD-B)

- Medial Thigh Support (Pommel/Abductor Height)**
 - Eliminate Completely (SC-MTE-B)
 - Increase height by _____” (SC-MTI-B)
 - Decrease height by _____” (SC-MTD-B)

- Patient LEFT Lateral Thigh Support (Adductor Height)**
 - Eliminate Completely (SC-LLTE-B)
 - Increase height by _____” (SC-LLTI-B)
 - Decrease height by _____” (SC-LLTD-B)

- Patient RIGHT Lateral Thigh Support (Adductor Height)**
 - Eliminate Completely (SC-RLTE-B)
 - Increase height by _____” (SC-RLTI-B)
 - Decrease height by _____” (SC-RLTD-B)

- Patient LEFT Leg Length**
 - Longer than Shape Capture by _____” (SC-CL-ALL-B)
 - Shorter than Shape Capture by _____” (SC-CL-ALS-B)

- Patient RIGHT Leg Length**
 - Longer than Shape Capture by _____” (SC-CL-ARL-B)
 - Shorter than Shape Capture by _____” (SC-CL-ARS-B)

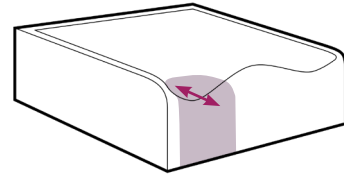
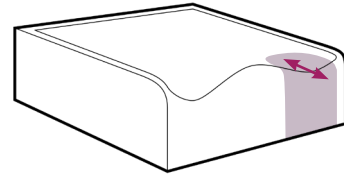
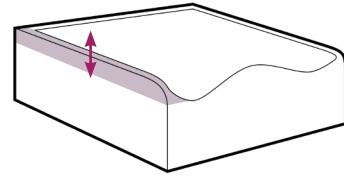
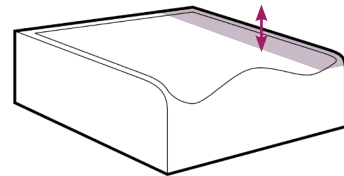
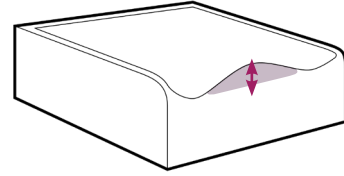
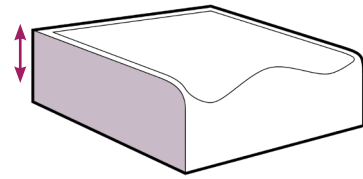

Cushion Accessory Options

- Seat Positioning Tray (SC-SPT)**
The seat positioning tray is an ABS rigid base that mimics the cushion’s underside and velcros securely onto the seat pan. Side and rear tabs guide the cushion back into proper alignment after removal.
- Seat Positioning Tray With T-Nut Upgrade (SC-SPT-TNU)**
With the pre-installed T-nut upgrade, the Seat Positioning Tray becomes a mounting platform capable of securely attaching back hardware brackets, positioning belts, thigh or knee support hardware, and a variety of adaptive accessories, allowing precise, repeatable alignment without the need to modify the tray.
- Integrated Rigidizer (SSMP)**
An ABS layer added to the bottom surface of a foam cushion **or** an internal reinforcement integrated within the base of an AIREZ cushion. This component helps maintain cushion shape, improve stability, and reduce seat-sling hammocking.
- Gel Insert *FOAM CUSHION ONLY* (SC-GEL)**
The gel is inserted under the ischial and sacral areas and layered with 1” memory foam on top.

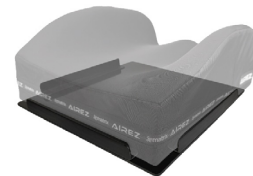

+\$350



+\$450

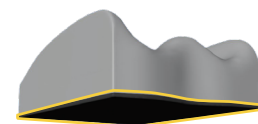

+\$395

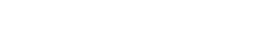

+\$998

APR. 1, 2026

